

Operating instructions

MEISTERSTÜCK (Gen.2)



sonoro

GERMAN AUDIO DESIGN
www.sonoro.com

Document information

Operating instructions for the device:

All-In-One Audio Music System MEISTERSTÜCK (Gen. 2)

- ▶ Read these instructions carefully.
- ▶ Keep the instructions accessible.
- ▶ Observe the instructions in the corresponding safety manual.
- ▶ When passing on the device, also hand over these instructions and the associated safety manual.

This Operating instructions is part of the product and protected by copyright.
Reproduction, reprinting and distribution only with permission.

Manufacturer:

sonoro audio GmbH
Hammer Landstraße 45
41460 Neuss
Germany

Tel. +49 2131 8834-141
Fax +49 2131 7517-599
support@sonoro.com



Do you need help?

- ▶ Visit our support website for more information.
<https://support.sonoro.com>

Table of contents

1. Safety information	6
1.1 Intended use	6
1.2 General safety instructions	7
2. Product information	8
2.1 Equipment	8
2.2 Scope of delivery	9
2.3 Front of device	10
2.4 Rear of device	11
2.5 Underside of device	12
2.6 Remote control	13
2.7 Display icons	14
2.8 Technical data	15
3. Setting up	17
3.1 Unpacking the device	17
3.2 Positioning the device	18
3.3 Preparing the remote control	18
3.4 Connecting antennas	19
3.4.1 Wi-Fi antennas	19
3.4.2 FM/DAB telescopic antenna	20
3.4.3 FM/DAB aerial	21
3.5 Establishing a power supply	22
3.6 Initial setup	23
3.7 Network connection	24
3.8 Sound optimisation	25
4. Operation	26
4.1 Control on the device	26
4.2 Control via the remote control	28
4.3 Functions	29
4.4 Main menu	31
4.4.1 Menu	31
4.4.2 Sound settings	31
4.4.3 Sleep timer	31
4.4.4 Alarm	31
4.4.5 Recently played	32
4.4.6 Recall from favorites	32
4.4.7 Settings	32

4.5	Sources	33
4.5.1	DAB Radio	34
4.5.2	FM Radio	35
4.5.3	Internet radio	36
4.5.4	Podcast	37
4.5.5	Bluetooth®	38
4.5.6	AUX	40
4.5.7	Digital	41
4.5.8	Streaming Music	42
4.5.9	CD	45
4.5.10	Streaming	46
4.5.11	Smart Home	47
4.6	Favorites	48
4.6.1	Device	48
4.6.2	Remote control	49
4.6.3	Internet	49
4.7	Settings	50
4.7.1	Network wizard	50
4.7.2	Network info	51
4.7.3	Language	51
4.7.4	Date and time	51
4.7.5	Device info	51
4.7.6	Software update	51
4.7.7	Factory reset	51
4.7.8	Streaming audio quality	52
4.7.9	Chromecast built-in	52
4.7.10	AirPlay password	52
4.7.11	Display settings	52
4.7.12	Power management	53
4.7.13	Privacy policy	53
5.	sonoro audio app	54
6.	sonoro web client	54
7.	Cleaning and care	55
8.	Troubleshooting	56
9.	Disposal	59
9.1	Disposing of the packaging	59
9.2	Disposing of the device	60

10. Appendix	61
10.1 Marks of conformity and certificates	61
10.2 Declaration of conformity	63

1. Safety information

1.1 Intended use

The device is suitable for the following:

- For playing analogue and digital radio stations that can be accessed via antenna.
- For playing streaming services, radio stations and podcast programmes accessible via the Internet.
- For playing from devices and to devices paired via Bluetooth®.
- For playing from external devices connected via the following inputs:
 - AUX 1
 - AUX 2
 - Optical
 - Coaxial
 - HDMI
 - USB
- For playing from CD's in the formats audio CD and MP3/WMA CD.
- For playing from media servers or streaming applications that are on the same network.
- For playing from sources or to devices connected via Smart Home systems.
- For charging external devices connected via the USB input.

The device is intended exclusively for use in private households.

Only use the device if it is in faultless technical condition and has been set up correctly. Any other use is considered contrary to the intended use.

Intended use also includes reading and observing these instructions and the associated safety manual.

1.2 General safety instructions

WARNING!

Danger due to non-observance of the safety instructions!

The associated safety manual contains important information for the safe use of the device. Special attention is drawn to possible dangers. Failure to observe these may result in serious injury or damage to the device.

- ▶ Read the associated safety manual and these instructions carefully.
- ▶ Follow the safety instructions.
- ▶ Store the documents in an accessible location.

Use of the device is prohibited in the following cases:

- In case of damage to the device or individual components.
- In the event of unauthorised conversions or modifications to the device.
- After improper repairs.

The manufacturer accepts no liability for damage in the following cases:

- If these instructions are not followed.
- In case of improper use.
- In case of improper handling.
- In the case of unauthorised conversions or modifications.

2. Product information

2.1 Equipment

Sound	<ul style="list-style-type: none"> • 2 tweeters 0.75" • 2 midrange drivers 3" • Subwoofer 5.25" • 5 separate Class-D amplifiers • Digital sound processor • Equalizer function to adjust bass and treble • 3D sound and dynamic bass function • Room correction app (iOS only, from iPhone 6)
Display	High-resolution 4" TFT colour display with automatic brightness adjustment.
FM / DAB+radio Station scan	Automatic and manual.
Sleep timer	Switch-off function with precise setting to the minute (5 - 120 min).
Favourites	A total of 99 memory locations.
Operation	<ul style="list-style-type: none"> • Directly on the device, via remote control, via the sonoro audio app or via the sonoro web client • Smart Home ready
Music transmission	<ul style="list-style-type: none"> • FM and Digital radio DAB+, internet radio, podcast • CD player with repeat and shuffle function • Bluetooth® (bidirectional), Qualcomm® aptX™ / aptX™ HD audio, Apple AirPlay audio, Chromecast built-in • Amazon Music™, Deezer™, Napster™, Qobuz™, Spotify Connect™, TIDAL Connect™ • DLNA, UPnP
Connections	<ul style="list-style-type: none"> • HDMI ARC / eARC (for TV / PCM only) • Digital optical and coaxial input • Analogue AUX IN (2 x) and LINE OUT • USB-A, USB-C (charging and playback function) • Headphones (3.5 mm jack)

2.2 Scope of delivery

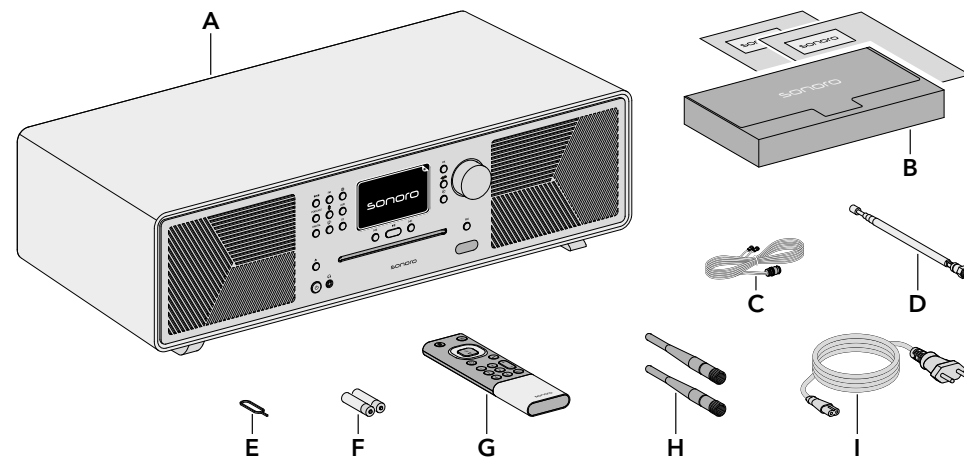

- A MEISTERSTÜCK (Gen. 2)
- B Document box with Quick Start Guide and safety manual
- C FM/DAB aerial
- D FM/DAB telescopic antenna
- E Battery compartment opener
- F 2 x AAA batteries (IEC LR03)
- G Remote control
- H 2 x Wi-Fi antennas
- I Power cable

Contents

Front of device

Rear of device

Support

Contents

Front of device

Rear of device

Support

2.3 Front of device

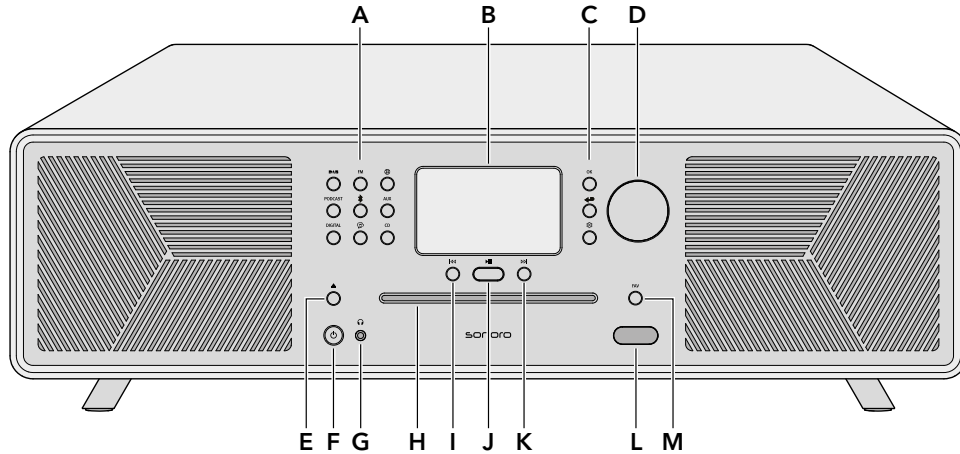

- | | |
|--|---|
| <p>A Source buttons</p> <ul style="list-style-type: none"> • DAB Radio (DAB) • FM Radio (FM) • Internet Radio (Globe icon) • Podcast (PODCAST) • Bluetooth® (Bluetooth icon) • AUX (AUX) • Digital (DIGITAL) • Streaming Music (Streaming icon) • CD (CD) <p>B Display</p> <p>C Navigation buttons</p> <ul style="list-style-type: none"> • OK button (OK) • Back button (Left arrow) • Main menu button (Gear icon) <p>D Rotary control</p> | <p>E CD eject button (▲)</p> <p>F Standby button (Power icon)</p> <p>G Headphone jack (Headphones icon)</p> <p>H CD slot</p> <p>I Previous title / station button (Left double arrow)</p> <p>J Play / pause button (Play/Pause icon)</p> <p>K Next title / station button (Right double arrow)</p> <p>L Infrared and light sensor</p> <p>M Favorites button (FAV)</p> |
|--|---|

2.4 Rear of device

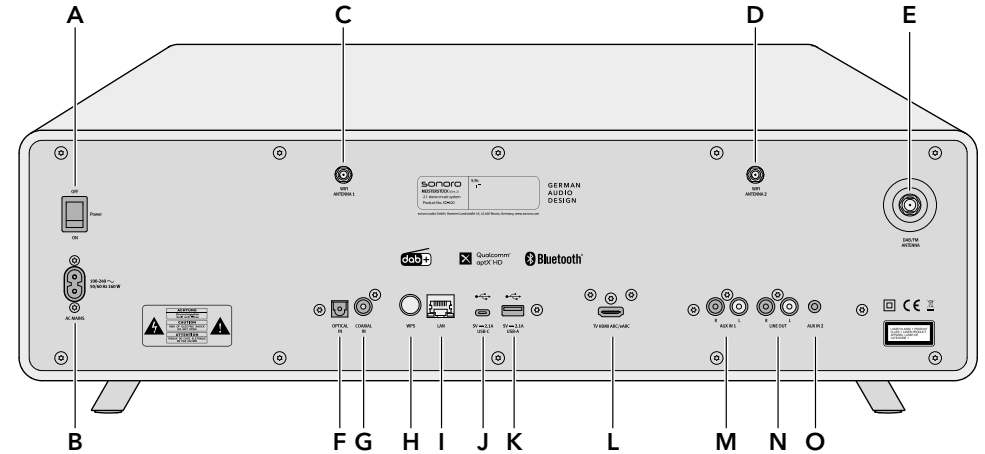

- | | |
|--|---|
| <p>A Main ON/OFF switch</p> <p>B Socket for power cable</p> <p>C Socket for Wi-Fi antenna 1</p> <p>D Socket for Wi-Fi antenna 2</p> <p>E Socket for FM / DAB aerial antenna / telescopic antenna</p> | <p>F Optical input</p> <p>G Coaxial input</p> <p>H WPS button</p> <p>I LAN socket RJ45</p> <p>J USB-C connection</p> <p>K USB-A connection</p> <p>L Television HDMI ARC / eARC connection</p> <p>M AUX 1 input (RCA)</p> <p>N LINE OUT output (RCA)</p> <p>O AUX 2 input (3.5 mm)</p> |
|--|---|

2.5 Underside of device

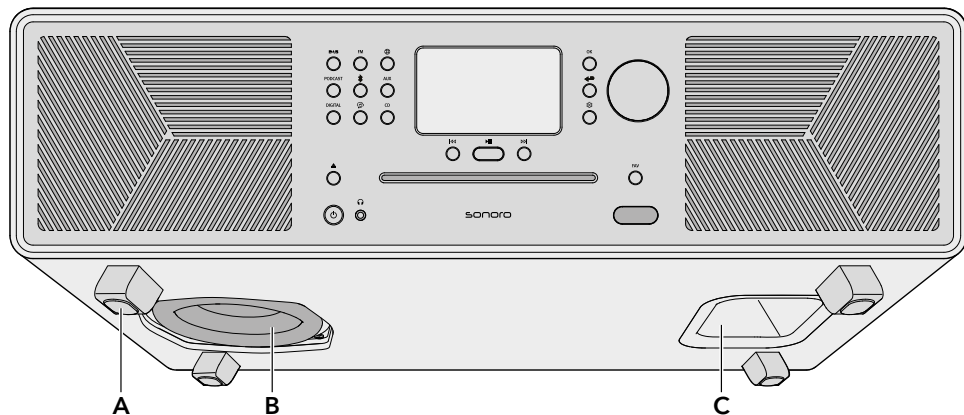

- A Feet
- B Subwoofer
- C Bass reflex port

2.6 Remote control

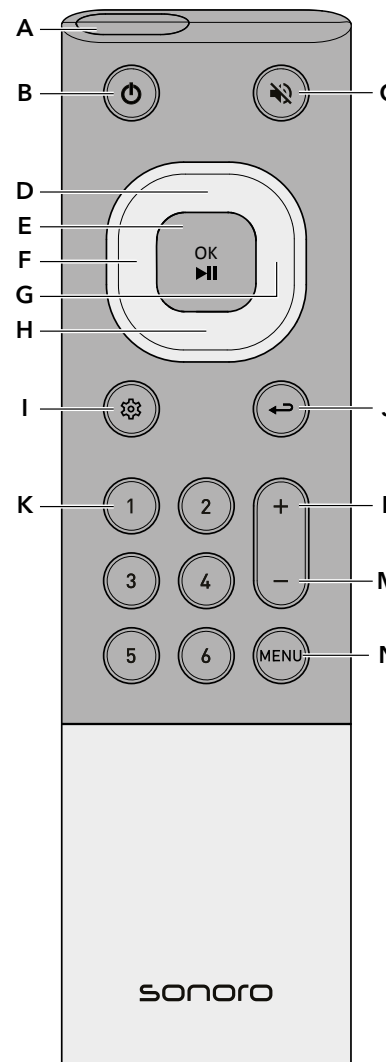

























- A Infrared sensor
- B Standby button
- C Mute / Unmute button
- D Top / Up button
- E OK / Play / Pause button
- F Left / Previous title / Station button
- G Right / Next title / Station button
- H Bottom / Down button
- I Main menu button
- J Back button
- K 6 favorites buttons
- L Volume up button
- M Volume down button
- N MENU button

On the back:

- Battery compartment with lock opening

2.7 Display icons

-  The Wi-Fi connection is established (with display of signal strength).
-  The Wi-Fi connection is interrupted.
-  The Wi-Fi connection is interrupted and is in configuration mode ("SoftAP").
-  The LAN network is connected.
-  The LAN network is disconnected.
-  Bluetooth is in searching / discoverable mode.
-  An audio Bluetooth device is connected.
-  A Bluetooth headset is connected.
-  The radio station / music track is in the favorites list.
-  The radio signal is being received (with display of the signal strength).
-  The playback mode "Repeat all" is active.
-  The playback mode "Repeat one" is active.
-  The playback mode "Repeat folder" is active.
-  Shuffle is active.
-  CD Resume is active.
-  The sleep timer is active.
-  The alarm is active.
-  The snooze function is activating.
-  The headphone is plugged in. (Only support 1 headphone.)
-  The sound output is muted.
-  The streaming playback is loading.
-  The streaming playback is buffering.
-  Playback is playing.
-  Playback paused.
-  Playback stopped.

2.8 Technical data

Dimensions	Approx. 570 x 262 x 168 mm (W x D x H)
Weight	Approx. 10.0 kg
Operating temperature	0 °C to +40 °C
Display	4" TFT colour display (800 x 480 px)
FM	Frequency range 87.50 MHz - 108.00 MHz
DAB/DAB+	Band III, 174.928 MHz - 239.200 MHz
Internet radio	Over 50,000 stations worldwide
Favorites	Total of 99 for FM Radio / DAB Radio / Internet Radio / Podcasts / Amazon Music / TIDAL / Deezer / Qobuz / My Music / Spotify (max. 20)
Supported CD formats	<ul style="list-style-type: none"> • CD-DA (12 cm), CD-R, CD-RW, • MP3 (max. 48 kHz, 320 kbps, 16 bit), • WMA (DRM not supported, max. 48 kHz, 320 kbps, 16 bit)
USB	Type C, type A - charging power 5 V DC, max. 2.1 A, System formats for playback: FAT, FAT 32, NTFS, EXT 2/3/4
Sensitivity AUX-IN	<ul style="list-style-type: none"> • AUX-IN 1 (RCA socket) 2000 mV / 1000 mV / 500 mV, • AUX-IN 2 (3.5 mm) 300 mV
Digital inputs	<ul style="list-style-type: none"> • Optical In (TOSLINK) - Linear PCM, STEREO, sampling rate 44.1 kHz ~ 192 kHz, bit depth 24 bit • Coaxial In (S / PDIF) - Linear PCM, STEREO, sampling rate 44.1 kHz ~ 192 kHz, bit depth 24 bit
HDMI	HDMI ARC / eARC (television) - PCM, STEREO, sampling rate max. 192 KHz, bit depth 16 bit, 24 bit
Headphone impedance	16 - 32 Ω
LINE OUT (RCA)	2 Vrms
Streaming profile	Bluetooth®, AirPlay, Chromecast built-in, compatible with UPnP
Supported network	IEEE 802.11 a/b/g/n/ac/ax 2 x 2 MIMO, 2.412 GHz - 2.472 GHz / 5.18 GHz - 5.70 GHz
Transmitted power	16.5 dBm (2.4 GHz), 19.4 dBm (5 GHz)
Network LAN	Ethernet, 10BASE-T/100BASE-TX

Encryption	WEP, WPA2 (PSK), WPA3, WPS
Bluetooth®	Version 5.0, AVRCP v1.6 profile, A2DP 1.3.1, 2.402 GHz - 2.480 GHz, SBC, AAC, aptX, aptX HD, range approx. 10 m
Transmitted power	BT 12.9 dBm, BLE 10.0 dBm
Supported audio formats	<ul style="list-style-type: none"> • WAV, FLAC & AIFF - max. 24 bit / 192 kHz • ALAC (Apple Lossless Audio Codec) - max. 24 bit / 192 kHz • AAC - max. 48 kHz, 320 kbps, 16 bit • MP3 - max. 48 kHz, 320 kbps, 16 bit • AAC (LC / HE-AAC / (v2) - max. 48 kHz, 320 kbps, 16 bit • OGG Vorbis and WMA - max. 48 kHz, 320 kbps, 16 bit • M4A - max. 48 kHz, 320 kbps, 16 bit
Supported playlist formats	ASX (Microsoft®), M3U, PLS / WPL
Remote control batteries	2 x LR03 (AAA), 1.5 V
Supply voltage	AC 100 - 240 V, 50/60 Hz
Deep sleep standby power consumption	< 0.5 W
Network standby power consumption	< 2.0 W

Specifications are subject to change without notice.

3. Setting up

📖 The instructions in the corresponding safety manual must be observed.

3.1 Unpacking the device

- ▶ Carefully unpack the device and all enclosed parts.
- ▶ Place the device in a suitable location.
- ▶ Check the device and all parts included for damage.
- ▶ Check the scope of delivery for completeness.
 - See chapter "2.2 Scope of delivery" (page 9).
- ▶ If possible, keep the packaging.

If parts are missing or damaged:

- ▶ Contact your dealer or sonoro customer service immediately.

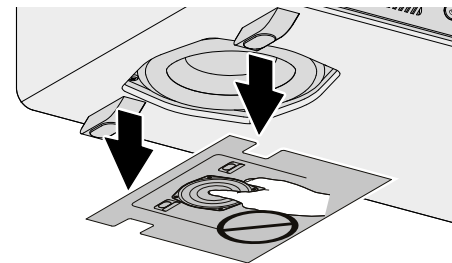

- ▶ Remove the protective cardboard from the subwoofer.

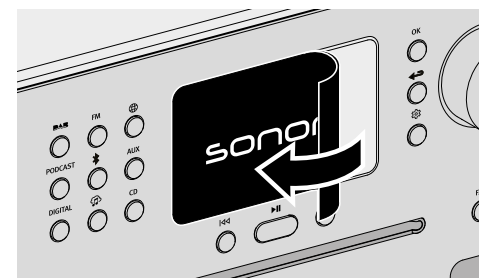

- ▶ Remove the protective film from the display.

3.2 Positioning the device

The following points must be observed when setting up the device:

- There must be no interfering objects or equipment in the vicinity (e.g. heat sources, metal, water, steam).
- The mains socket used must be accessible at all times.
- Stains may appear on natural wood with oiled or waxed surfaces.

- ▶ Choose a suitable location for the device.

3.3 Preparing the remote control

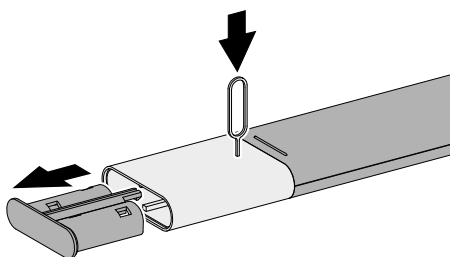

- ▶ Open the battery compartment.

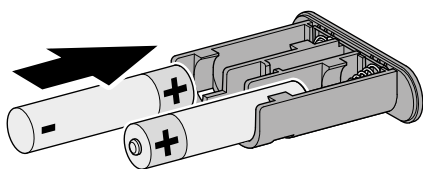

- ▶ Insert two batteries (AAA IEC LR03) correctly.

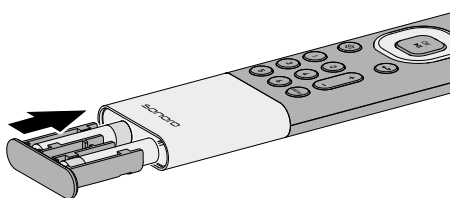

- ▶ Close the battery compartment.

3.4 Connecting antennas

For reception in the wireless network, connect the two Wi-Fi antennas.

An aerial and a telescopic antenna are available for radio reception (FM/DAB).

Alternatively, the device can be connected directly to a connection on the house aerial using a suitable aerial cable (F connector not included in the scope of delivery).

3.4.1 Wi-Fi antennas

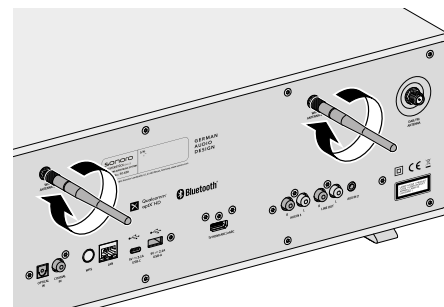

- ▶ Screw on the antennas.

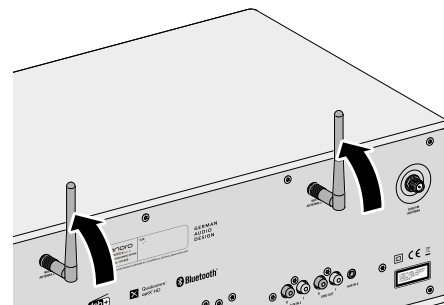

- ▶ Point the antennas upwards.

3.4.2 FM/DAB telescopic antenna

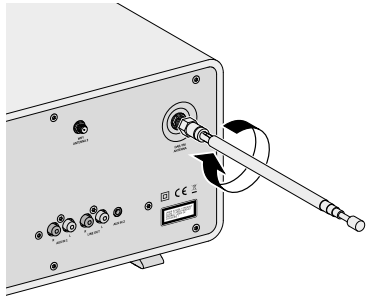

- ▶ Screw on the antenna.

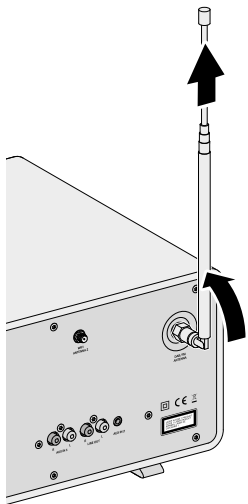

- ▶ Pull out the antenna completely.
- ▶ Align the antenna so that the reception is optimal.

3.4.3 FM/DAB aerial

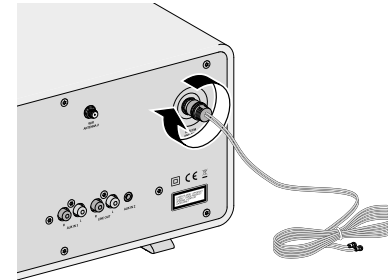

- ▶ Screw on the antenna.

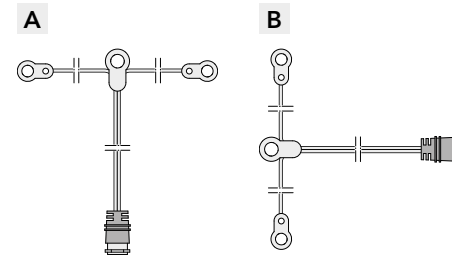

- ▶ Unfold the antenna so that both ends and the cable form a "T".
 - ▶ Align the antenna so that the reception is optimal.
- A Recommendation for FM radio reception: Both ends horizontal.
- B Recommendation for DAB radio reception: Both ends vertical.

3.5 Establishing a power supply

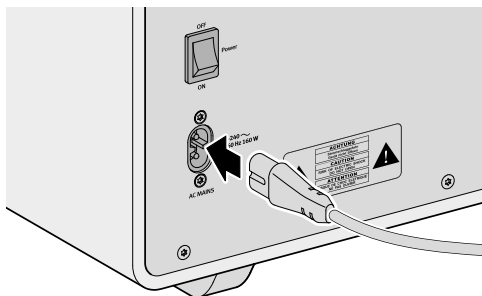

- ▶ Plug the power cable into the device.

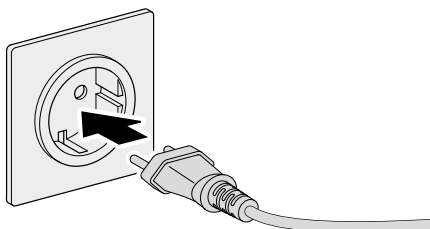

- ▶ Connect the power cable to the mains socket.
- ▶ Make sure that the mains socket used is accessible at all times.

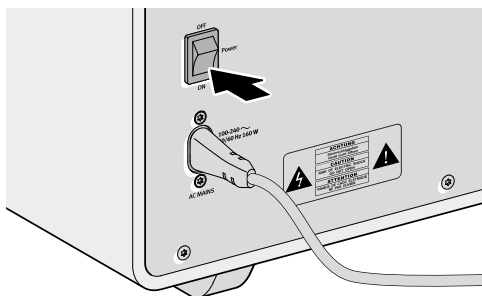

- ▶ Switch on the main switch.

3.6 Initial setup

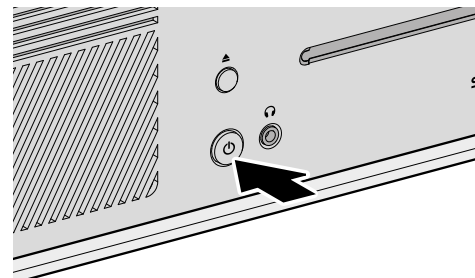

- ▶ Switch on the device.
 - ▶ Wait a few seconds.
- The setup wizard starts automatically.

Information on the control and operation of the setup wizard:

→ See chapter "4.1 Control on the device" (page 26).

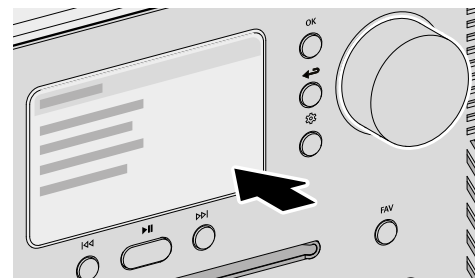

- ▶ Follow the instructions shown on the display.
- ▶ Accept the privacy policy.
- ▶ Set the language, region, country and time zone.

For immediate use, Chromecast built-in can be started directly during setup or alternatively at a later time.

→ See chapter "4.7.9 Chromecast built-in" (page 52).

Setup includes the connection to the network.

→ See chapter "3.7 Network connection" (page 24).

The initial setup includes an automatic update search for the device. We recommend that you to confirm an update.

Completion of the setup is confirmed with a message on the display:

"Setup is complete - congratulations! The device is set up."

3.7 Network connection

WLAN

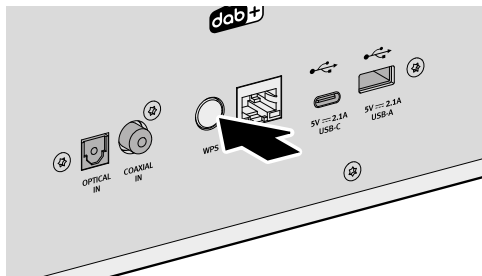

- ▶ Briefly press the WPS button on the back of the device.

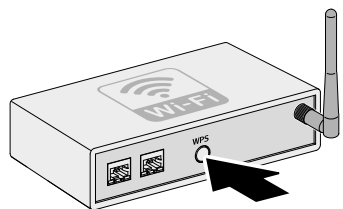

- ▶ Then briefly press the WPS button on your router.

The connection is established automatically 

LAN

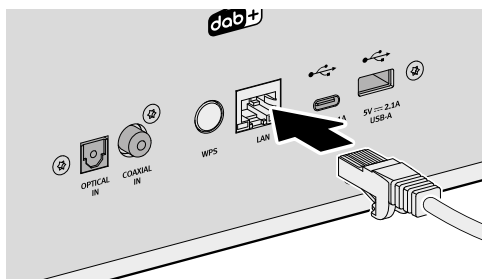

- ▶ Connect the LAN cable with the device.

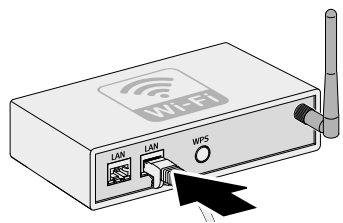

- ▶ Connect the LAN cable with your router.

The connection is established automatically 

Further connection options:

Main menu ⇨ Settings ⇨ Network wizard

→ See chapter "4.7.1 Network wizard" (page 50).

3.8 Sound optimisation

The sonoro Room correction app is available for automatic adjustment of the sound to the room situation where the device is set up. The app uses digital filters to compensate for sound deviations that may occur due to individual spatial conditions.



The sonoro Room correction app is available for iOS, from iPhone 6.

Apple App Store (iOS)



- ▶ Press the main menu button.
- ▶ Select Sound settings ⇨ Room correction EQ ⇨ Start to setup room correction
- ▶ Open the sonoro Room correction app on your iPhone.
- ▶ Follow the instructions.

4. Operation

The following options are available for operating the device:

- Directly on the device.
 - See chapter "4.1 Control on the device" (page 26).
- Via the remote control.
 - See chapter "4.2 Control via the remote control" (page 28).
- Via the app.
 - See chapter "5. sonoro audio app" (page 54).
- Via the web client.
 - See chapter "6. sonoro web client" (page 54).

4.1 Control on the device

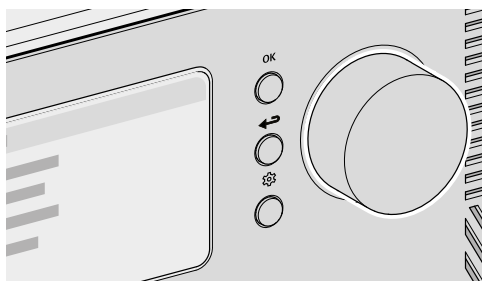

The device is controlled and operated using the navigation keys and the rotary control (e.g. to select menu items or follow the instructions on the display).



If a menu is currently being displayed:

- ▶ Turn the controller to select a menu item or input.

If a source is currently playing:

- ▶ Turn the controller to adjust the volume.

OK

If a menu is currently being displayed:

- ▶ Press the OK button to confirm the selection.

When a source is playing and a station image or music track cover appears on the display:

- Pressing the OK button briefly displays information about the station or track.
- Pressing and holding the OK button enlarges the display.
- By briefly pressing the OK button again, the previous display reappears.



If a menu is currently being displayed:

- ▶ Press the back button to go back to the previous menu.

If a source is currently playing:

- ▶ Press the back button to enter the submenu of the source.



- ▶ Press the main menu button to access the main menu.

4.2 Control via the remote control

The device can also be controlled and operated via the remote control (e.g. to select menu items or follow the instructions on the display).



If a menu is currently being displayed:

- ▶ Use the up and down buttons to select a menu item or item of information within a menu.
- ▶ Use the left and right buttons to change the menu.
- ▶ Press the OK button to confirm the selection.



If a menu is currently being displayed:

- ▶ Press the button to confirm the selection.

If a source is currently playing:

- ▶ Press the button to mute / unmute or play / pause



If a menu is currently being displayed:

- ▶ Press the back button to go back to the previous menu.

If a source is currently playing:

- ▶ Press the back button to enter the submenu of the source.



- ▶ Press the main menu button to access the main menu.



If a source is currently playing:

- ▶ Use the + and - buttons to change the volume.

4.3 Functions

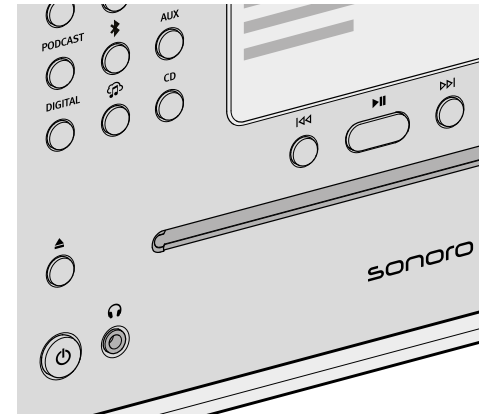

The following functions are accessed directly via buttons on the device or on the remote control.



- Switch on
The device starts with the last selected playback source.
- Switch off
The device switches to standby mode.

When the device is switched on but not playing and not being operated:
After the standby timeout has expired (default setting 15 minutes), the device automatically switches to network standby mode.

→ See chapter "4.7.12 Power management" (page 53).



- Play
Playing a playback source is continued.
- Pause
Playing a playback source is paused.



- Press
The playback source changes to the previous title, station or frequency.
- Press and hold
If the playback source allows it, a rewind within the current title takes place (e.g. with CD, podcast or My Music) or a station scan (with FM radio).

Contents

Front of device

Rear of device

Support



- Press
The playback source changes to the next title, station or frequency.
- Press and hold
If the playback source allows it, fast forward within the current title (e.g. with CD, podcast or My Music) or station scan (with FM radio).



- Play
Inserting a CD into the CD drive automatically starts playback of the CD.
Further information on playing CD's:



- Eject
The CD in the CD drive is ejected.



- Listen
Inserting the jack plug into the headphone socket on the device results in playback on the connected headphones; playback on the speakers is deactivated.
When the headphone is connected via the headphone jack, playback sound via loudspeakers is not possible.

FAV → See chapter "4.6 Favorites" (page 48).

More information on selecting playback sources via dedicated buttons:

→ See chapter "4.5 Sources" (page 33).

Contents

Front of device

Rear of device

Support

4.4 Main menu



Setting options can be reached via the main menu.

4.4.1 Menu

To select the desired playback source.

→ See chapter "4.5 Sources" (page 33).

4.4.2 Sound settings

To adjust the sound to your own preferences (e.g. treble, bass).

The following options are available for selection in the menu:

- 3D Sound - Turning on and off
The function changes the sound of the speakers to enhance the spatial effect.
- Dynamic Bass - Turning on and off
The function extends the lower frequency range and boosts the bass depending on the signal level.
- Bass - from -12 dB to +12 dB
- Treble - from -12 dB to +12 dB
- Room correction EQ - Turning on and off
→ See chapter "3.8 Sound optimisation" (page 25).

4.4.3 Sleep timer

For selecting and setting the automatic switch-off function. The desired time interval can be set in 5-minute steps up to a maximum of 120 minutes.

The activated sleep timer is indicated by the  icon. The sleep timer can be ended immediately by switching off the device.

4.4.4 Alarm

To set up the alarm function with your own settings. The menu includes the following options:

- Alarm list
Stored wake-up times are managed in the alarm list. After selecting an alarm time, the stored settings can be confirmed, changed or deleted. Each editing of a wake-up time must be confirmed by saving.

- Add alarm

To appear in the alarm list, a desired alarm time must be added with the following settings saved:

- Active - Off, Daily, Once, Weekdays, Weekends or a specific day of the week.
- Time - Time to the minute.
- Sound - Alarm tone "Morning vibes" or a source from the favorites.
- Volume

The setting of the alarm time must be confirmed by saving.

The activated alarm is indicated by the  icon. In standby, the alarm time is displayed at the bottom.

Snooze function

The alarm can be temporarily silenced by pressing the OK, Play / Pause or Mute button. The snooze function icon  flashes and the remaining time is displayed.

The duration (default setting 10 minutes) can be changed (5, 10, 15, 20, 30, 45 or 60 minutes) using the rotary control or the Up / Down buttons on the remote control.

Pressing the standby button ends the snooze function.

4.4.5 Recently played

Calls up the list with the most recently played sources.

If the storage spaces are exceeded, the oldest entry is overwritten.

4.4.6 Recall from favorites

To call up a previously saved source (e.g. radio stations, titles from streaming services or podcast programmes).

→ See chapter "4.6 Favorites" (page 48).

4.4.7 Settings

For selecting general setting options of the device (e.g. network, language, time, factory reset).

→ See chapter "4.7 Settings" (page 50).

4.5 Sources

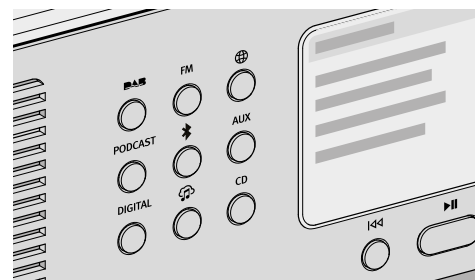

Selection of the desired playback source.

The following options are available:

- Dedicated buttons directly on the device.
 - The following buttons offer the option of selecting other sources:
 - AUX - See chapter "4.5.6 AUX" (page 40).
 - DIGITAL - See chapter "4.5.7 Digital" (page 41).
 - Streaming music - See chapter "4.5.8 Streaming Music" (page 42).
- Main menu selection ⇄ Menu.
- MENU button on the remote control.

When a source is playing and shown on the display:

- Pressing the back button or selecting the source again calls up the source submenu.
- After pressing the back button in the submenu, the source is shown again on the display.

Buttons on the device or on the remote control (e.g. favorites, play, pause, change to the next or previous title) are available for all play sources.

Contents

Front of device

Rear of device

Support

4.5.1 DAB Radio



For playing digital radio stations that can be received via antenna. An automatic search is carried out the first time the device is started.

Submenu:

- Station list
 - When started, automatic scanning is carried out, available stations are stored in the station list.
- Rescan
- Manual tuning
- Prune invalid stations
 - When calling up a station that is no longer being received, an error message "Error-failed to start playback" appears.
 - After a rescan, stations that can no longer be received are marked as invalid in the station list with "?" in front of the station name.
 - Confirming this menu item removes invalid channels from the list.
- DRC ("Dynamic Range Compression")
 - Some DAB radio stations offer dynamic range compression (DRC).
 - Compressing the dynamic range of a radio signal can increase the volume of quiet sounds and decrease the volume of loud sounds. Use of the function is recommended for noisy environments.
- Station order
 - Alphanumeric (default setting)
 - Ensemble
 - Valid

Contents

Front of device

Rear of device

Support

4.5.2 FM Radio



For playing analogue radio stations that can be reached via antenna. An automatic search is carried out the first time the device is started.

Submenu:

- Station list
 - When started, automatic scanning is carried out, available stations are stored in the station list with indication of the frequency.
- Save station
 - Stations can be stored manually after scanning with the "Left / Previous Station" and "Right / Next Station" buttons.
- Scan setting
 - Strong stations only (default setting)
 - All stations
 - Press and hold the "Left / Previous station" or "Right / Next station" button to perform corresponding scanning.
- Audio settings
 - Listen in stereo FM (default setting)
 - Listen in mono FM
- Scan
 - Enter the term in the menu item "Scan", start the function after selecting the menu item "Scan".

Contents

Front of device

Rear of device

Support

4.5.3 Internet radio



For playing radio stations that are accessible via streaming over the Internet.

Submenu:

- Favorites
To call up previously saved Internet radio stations from the favorites list.
- History
To call up the last Internet radio stations played.
- Recommendations
- Local stations
- Popular stations
- Trending
- High quality
- New stations
- Filter
 - By location
 - By language
 - By genre
- Search
Enter the term in the menu item "Search", start the function after selecting the menu item "Search".

Contents

Front of device

Rear of device

Support

4.5.4 Podcast

PODCAST For playing back podcast programmes that can be accessed via streaming on the Internet.

Submenu:

- Favourites
To call up previously saved podcast programmes from the favorites list.
- History
To call up the most recently played podcast programmes.
- Popular podcasts
- Trend
- Filter
 - By place
 - By language
 - By genre
- Search

4.5.5 Bluetooth®

- ▶ For playback from paired audio sources (e.g. smartphone, tablet, computer) and to paired Bluetooth devices (e.g. headphones, sound box, speakers) within a range of approx. 10 metres.



Before connecting to a Bluetooth device

- ▶ Disconnect an existing connection on the Bluetooth device.
- ▶ Make sure the Bluetooth device is in discovery mode and ready for pairing.
- ▶ The instructions for the Bluetooth device must be followed.

Connecting to a Bluetooth device for the first time

- ▶ Press the Bluetooth button on the device or select Bluetooth from the menu. When the  icon flashes, the device is in searching mode.
- ▶ Start scanning automatically.
- ▶ Wait until the name of the Bluetooth device is displayed.
- ▶ Select the Bluetooth device.
- ▶ Press the OK button to confirm.
- ▶ Select "Pair".
- ▶ Press the OK button to confirm.

When the devices have been successfully paired:

- The message "Bluetooth paired" appears briefly on the display.
- The  or  icon (for headphone) is displayed.

An active connection with a paired audio source or a paired Bluetooth headphone is displayed with "Name of Bluetooth device | Active".

Submenu:

- Searching for Bluetooth devices
The searching time is 30 seconds
- Paired audio sources devices
Active or already paired audio sources (e.g. smartphone, tablet, computer) are displayed.
- Paired headphones / speaker devices
Active or already paired Bluetooth devices (e.g. headphones, soundbox, speakers) are displayed.
- New devices
All new Bluetooth devices are displayed. - max. 6 devices

Connecting to an already paired Bluetooth device

The last connected Bluetooth device is automatically reconnected.

For other previously paired Bluetooth devices:

- ▶ Press the Bluetooth button on the device or select Bluetooth from the menu.
- ▶ Select the Bluetooth device.
- ▶ Press the OK button to confirm.
- ▶ Select "Connect".
- ▶ Press the OK button to confirm.

Disconnecting from a paired Bluetooth device

- ▶ Press and hold the Bluetooth button on the device.
Disconnection from the Bluetooth device is confirmed on the display.

Unpairing a Bluetooth device

- ▶ Call up the Bluetooth submenu.
- ▶ Select the Bluetooth device.
- ▶ Press the OK button to confirm.
- ▶ Select "Unpair".
- ▶ Press the OK button to confirm.

Contents

Front of device

Rear of device

Support

4.5.6 AUX

AUX For playback of external devices connected via the inputs "AUX 1" or "AUX 2".

- AUX In 1
Press the back button to adjust the input sensitivity:
 - Low (2000 mV)
 - Medium (1000 mV), default setting
 - High (500 mV)
- AUX In 2
The input sensitivity is fixed (300 mV).

Contents

Front of device

Rear of device

Support

4.5.7 Digital

DIGITAL To playback from external devices connected via the "Optical", "Coaxial" or "HDMI" inputs.

Audio latency compensation is a function to adjust a time offset between video and audio signals. The value is adjustable from 0 ms (default setting) to 480 ms.

- Optical input
 - Audio latency compensation
- Coaxial
 - Audio latency compensation
- HDMI

When connecting to the television, make sure that the appropriate output "eARC" or "ARC" is selected.

- HDMI CEC ("Consumer Electronics Controls") - Turning on and off
Function to use the control commands from or on an external device connected via an HDMI cable.
Use of the function may result in increased network standby power consumption.
- Audio latency compensation

4.5.8 Streaming Music



For playback from sources:

- My Music -USB-A, UAB-C and UPnP / DLAN music server.
- Music services - Amazon Music®, Deezer®, Napster®, Spotify / Connect®, TIDAL / Connect®

⚠ ATTENTION!

Risk of material damage due to improper handling!

Connection to live equipment may cause voltage damage to the device.

- ▶ Never connect the device to the USB port of a computer or to storage media (e.g. external hard drive) connected to the power supply.

My Music

For playback from sources:

- External devices that are connected via "USB" inputs.
- Media servers that are on the same network.

Submenu:

- Shared Music

The connected network is searched for sources with audio files. When a media server that has been found is selected, the audio files it contains can be played on the device. The selection is made according to the file structure on the media server.

- USB-A
Access to content according to existing file structure.
- USB-C
Access to content according to existing file structure.
- Play queue
 - "Play queue is empty"
 - "Try to add some songs to the play queue"

To add a title to the play queue:

- ▶ Select a source in "My Music".
- ▶ Select a title without confirming the title.
- ▶ Press and hold the Play / Pause button.
- ▶ Select "Add to play queue".
- ▶ Select "Now", "After current" or "Append".

- Playlists
 - "Create new playlist"
 - Select existing playlist

To add a title to a playlist:

- ▶ Select a source in "My Music".
- ▶ Select a title without confirming the title.
- ▶ Press and hold the Play / Pause button.
- ▶ Select "Add to Playlist".
- ▶ Select "Now", "After current" or "Append".

- Shuffle
 - Shuffle on
 - Shuffle off
- Repeat
 - Repeat all
 - Repeat one
 - Repeat folder
 - Repeat off

Music services

The following music services can be connected via the device or via the sonoro audio app:



Amazon Music®



Deezer®



Napster®



Qobuz®

The following music services can be connected via the device or via the sonoro audio app and also offer direct control via the app of the streaming provider:



Spotify Connect®



TIDAL Connect®

 For further information, please refer to the documentation (e.g. instructions, websites) of the respective streaming provider.

4.5.9 CD

CD For playing back from CD's in the CD drive in the formats Audio CD and MP3/WMA CD.

Inserting a CD into the CD drive starts playback automatically.

Submenu:

- Display of information about the inserted CD (e.g. type, tracks, duration). The title names are displayed for CD's equipped with corresponding information.
- Shuffle - Turn on and off.
- Repeat
 - Repeat all
 - Repeat one
 - Repeat folder (only for CD's with folder structure)
 - Repeat off
- Resume playback
 - Resume on
 - Playback starts from the last position played.
 - This function is also available when the playback source has been changed or the device has been switched to standby mode (e.g. helpful for audio books).
 - The function is terminated by "Resume off", by ejecting the CD or by switching off the device with the main switch.
 - Resume off

4.5.10 Streaming

The device is prepared for data transfer and content playback by connecting to streaming applications.

→ See chapter "10.1 Marks of conformity and certificates" (page 61).

- Chromecast-built-in

The connection is possible if the smartphone or tablet is connected to the device via the same wireless network.

- Google Home

Setup takes place via the Google Home app when the smartphone or tablet is connected to the device via the same wireless network.

- AirPlay

The connection is possible if the iOS device is connected to the device via the same network.

- Spotify Connect®

Use your phone, tablet or computer as a remote control for Spotify. Go to spotify.com/connect to learn how

- TIDAL Connect®

Control is directly via the TIDAL app when the smartphone or tablet is connected to the device via the same wireless network.

4.5.11 Smart Home

The device is prepared for playback from sources or to devices connected via building automation systems ("Smart Home").

The following operation of the device is possible via Smart Home:

- Turn the device on and off.
- Select the desired playback source.
- Call up functions (e.g. play / pause, previous / next title or station).
- Adjust the volume (including mute).
- Play playlists (including repeat or shuffle).
- Recall from favorites.

Work on electrical equipment in the building must be carried out by qualified electricians exclusively. Experience is required for programming the software.

To connect the device to a Smart Home system:

- ▶ Contact a sonoro Smart Home specialist dealer or sonoro customer service.

The following systems can be combined with the device.

- Busch-free@home

Prerequisites:

- Busch-free@home is set up, the software is up to date.
- The devices are on the same network.

- KNX

Prerequisites:

- ISE KNX Connect sonoro is available.
- Suitable ETS software from the KNX Association is available subject to a fee.

- Gira X1

Prerequisites:

- Gira X1 logic device and Gira Project Assistant are available.

- Control4

📖 For further information, please refer to the documentation (e.g. manuals, websites) of the respective system.

4.6 Favorites

4.6.1 Device

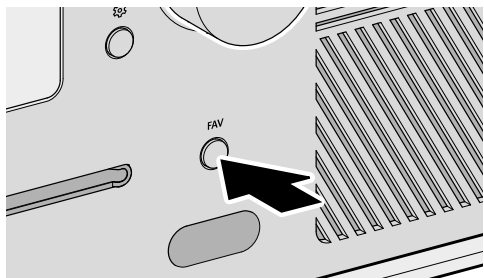

The device has space to store 99 favorites, e.g. for:

- Radio stations
- Titles from streaming services
- Podcast broadcasts

To save a favorite on the device, the desired source must be playing.

FAV ▶ Press and hold the button until the favorites list is displayed.

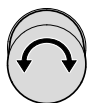

▶ Select a storage space.

OK ▶ Press the button to confirm.

To call up a favorite on the device:

FAV ▶ Briefly press the button. The favorites list is displayed.

- Favorites on the device
- Internet radio favorites
- Podcasts favorites

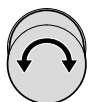

▶ Select the favorite.

OK ▶ Press the button to confirm.

4.6.2 Remote control

The first 6 storage spaces in the favorites list can also be called up via the direct button on the remote control. To add a favorite, the desired source must be playing.



▶ Press and hold one of the six buttons to save the favorite in that position.

▶ Press the button briefly to call up the favorite.

4.6.3 Internet

For sources that offer content from internet servers or the cloud (e.g. internet radio, podcasts, music services), additional storage space is available.

Favorites can be saved and called up in a separate folder that is automatically named after the source.

4.7 Settings

4.7.1 Network wizard

Connection to the network can be established by radio (wireless) or by cable (LAN).

If your router supports setup via WPS ("Wi-Fi Protected Setup"), the device can establish a fast and secure connection to the wireless network via its own WPS button.

The following options are available for selection in the menu:

- Configure connection (wireless)
 - Scan network

For manual selection of the network with entry of the network key via the navigation keys and the rotary control.
 - WPS button

For automatic connection via the WPS button on the device.
 - WPS Pin code

To call up a pin code to be entered on the router web page.
 - Manual (DHCP enabled or DHCP disabled)

For manual connection to the network and individual configuration options.
If DHCP ("Dynamic Host Configuration Protocol") is activated, settings and information (e.g. IP address, subnet, gateway, DNS) are assigned automatically.
- Configure wired
 - DHCP disabled

Settings and information (e.g. IP address, subnet, gateway, DNS) are assigned manually.
 - Automatic DHCP

Settings and information (e.g. IP address, subnet, gateway, DNS) are assigned automatically.
- Network type

To preset the desired connection method.

 - Automatic
 - Wireless (WLAN)
 - Wired
- Reset network settings

To delete the existing network connection or to set it again in case of connection problems.

4.7.2 Network info

After calling up, the following information is displayed:

- Status
- Network type
 - Wireless / Wired
- SSID
- Encryption
- IPv4 address
- Mask
- IPv6 address
- Auto-configured
- Gateways
 - IPv4 address
- DNS
 - IPv4 address
 - IPv6 address
 - IPv6 address

4.7.3 Language

To select the set language.

4.7.4 Date and time

- Set time format - 12 hours or 24 hours
- Country and region

The date and time are automatically retrieved from the Internet. If there is no internet connection, the date and time are set via DAB/FM.

4.7.5 Device info

After calling up, the following information is displayed:

- Device name
- Device ID
- Serial number
- Software information
 - sonoroSDK
 - Spotify
- MCU
- DSP
- Bluetooth
- CD servo
- DAB/FM
- HDMI

There is an editing option for the device name.

4.7.6 Software update

- Check for update
- USB update

4.7.7 Factory reset

To set the device back to the factory defaults. All saved settings are deleted. The device must be set up again.

4.7.8 Streaming audio quality

Adjustable for Amazon Music®, Napster®, Qobuz® and TIDAL Connect®.

- Low
- Normal
- High
- Premium

4.7.9 Chromecast built-in

Chromecast built-in can be started directly when setting up the device ("Cast is enabled") or at a later time ("Activate Cast").

- Send device usage and crash reports by selecting "Yes" or "No".
- Referral links
 - Learn how to Cast
 - Chromecast enabled apps
 - Google Terms of Service
 - Google Privacy Policy
 - Help improve Chromecast built-in

4.7.10 AirPlay password

To request a one-time password on the screen from the iOS device.

- ▶ Password
- ▶ Clear password

4.7.11 Display settings

- Brightness setting - Automatic or manual
- High ambience
- Low ambience
- Return to play-screen time
 - Turn off
 - 15 seconds (default setting)
 - 30 seconds
 - 1 minute

- Screen timeout in standby
 - Display always on (default setting)
 - 15 seconds
 - 1 minute
 - 5 minutes
- List gradience - On or Off

Here the focus is placed on the current menu selection by dimming down other menu items.

4.7.12 Power management

- Standby timeout

When the device is switched on but not playing and not being operated: Setting of the length of time until the device switches off automatically.

 - Off
 - 10 minutes
 - 15 minutes (default setting)
 - 20 minutes
 - 30 minutes
- Inactive standby

When the device is switched on and playing but not being operated: Setting of the length of time until the device switches off automatically.

 - Off (default setting)
 - 2 hours
 - 4 hours
 - 8 hours
 - 12 hours
- Deep sleep mode - Enable or Disable (default setting is "Disable")

If the device has been switched to standby mode, the set alarm has no function in deep sleep mode. The device cannot be recognised on the network.

4.7.13 Privacy policy

Access to the sonoro privacy policy via a QR code and "Accept" prompt.

5. sonoro audio app



The sonoro audio app is available for controlling the device via smartphone or tablet.

Apple App Store
(iOS)



Google Play Store
(Android)



Further functions and options are available when the app is used.

Better sound is possible when a smartphone or tablet connects to the device via the same wireless network than if connection is established via Bluetooth®.

6. sonoro web client

The IPv4 address of the device is required for using the sonoro web client.

→ See chapter "4.7.2 Network info" (page 51).

- ▶ Enter the IPv4 address of the device in the address line of the web browser (only the numbers separated by a dot, e.g. "192.168.0.23").

The device can be operated via the web browser.

7. Cleaning and care

⚠ ATTENTION!

Risk of property damage due to improper cleaning!

Sharp-edged objects, abrasive cleaners or unsuitable cleaning agents can damage the surface of the device. Incorrect cleaning measures can restrict the functionality.

- ▶ Never use abrasive or solvent-based cleaning agents.
- ▶ Never use hot or compressed air to dry the device.
- ▶ Protect edges and corners of the device from excessive pressure.

-
- Fingerprints and light soiling:
 - ▶ Only clean the outside of the device with a soft, dry cloth.
 - Heavy soiling:
 - ▶ Only clean the outside of the device with a slightly damp cloth.
 - ▶ Then dry the device with a soft, dry cloth.

8. Troubleshooting

Possible malfunctions are described as follows:

Description of the fault.

- Possible cause.
 - ▶ Remedy the fault.
 - Reference to corresponding chapter.

The device does not switch on.

- No power supply.
 - ▶ Check the power supply (e.g. fuse from the circuit).
 - ▶ Make sure that the power cable is connected correctly.

The device does not respond.

- Error on the device.
 - ▶ Disconnect the device from the power supply for a few seconds (e.g. unplug the power cable).
 - ▶ Switch the device on again.

The device automatically switches to standby mode.

- The sleep timer is activated.
 - ▶ Switch on the device.
 - ▶ Start playback again.
- The inactivity standby function is active because the device has not been used for the set time.
 - ▶ Switch on the device.
 - ▶ Start playback again.

Poor sound quality.

- Interference from other radio transmitters or devices.
 - ▶ Increase the distance to other devices.
 - ▶ To connect via HDMI, use a good, shielded HDMI cable.

The remote control does not react or reacts incorrectly.

- The distance to the device is too great.
 - ▶ Reduce the distance between the remote control and the device.
- The battery is empty.
 - ▶ Replace the battery.
 - See chapter "3.3 Preparing the remote control" (page 18).

No connection to the wireless network.

- The router is too far away or communication is blocked.
 - ▶ Make sure that the router is not shielded.
 - ▶ Place the device closer to the router.
 - ▶ Change the orientation of the Wi-Fi antennas.
- The router is not switched on or is not working properly.
 - ▶ Switch on your router.
 - ▶ Check the status of the router.
- Incorrect set-up procedure.
 - ▶ Check that your router supports WPS and uses the correct setup procedure (PBC or PIN).
 - ▶ Repeat the connection process.
 - See chapter "3.7 Network connection" (page 24).

No sound audible.

- The sound is switched off.
 - ▶ Adjust the volume.
- The device is not in the correct play mode.
 - ▶ Select another playback source.
- The headphone is plugged in.
 - ▶ Disconnect the headphone plug.
- No FM/DAB reception.
 - ▶ Connect or align the FM / DAB antenna.
- No network connection.
 - ▶ Check the connection.
 - See chapter "4.7.1 Network wizard" (page 50).
- No sound from the external device connected via the optical or coaxial input.
 - ▶ Select PCM as the output on the external device.
- No sound from the television connected via the "HDMI" input.
 - ▶ Use the HDMI socket "eARC" or "ARC" on the television.
 - ▶ Select PCM as the output on the external device.

Playback of the CD in the CD drive does not start.

- The CD format is not supported.
 - ▶ Make sure that the CD corresponds to the audio CD or MP3/WMA CD format.
- The CD is dirty.
 - ▶ Clean the CD.
- The CD is damaged.
 - ▶ Use another CD.

Internet radio station does not work from time to time.

Contents

Front of device

Rear of device

Support

Contents

Front of device

Rear of device

Support

- Some stations only support a limited number of listeners.
 - ▶ Try again later.
- The radio station is not broadcasting.
 - ▶ Try again later.

Internet radio station disappears from the station list.

- The station is removed from the list if it is not transmitting.
 - ▶ Try again later. When the station is transmitting again, it will reappear in the list.

The USB device does not work.

- Playback is not supported.
 - ▶ Check files and the file system on the USB device.
- There are hidden files on the USB device.
 - ▶ Remove the hidden files from the USB device.

The USB device is not charging.

- No connection to the USB device.
 - ▶ Check the USB cable.

The Bluetooth connection does not work.

- Bluetooth is already connected to another Bluetooth device.
 - ▶ Disconnect the connected device and try again.
- The Bluetooth device has problems.
 - ▶ Switch Bluetooth on the Bluetooth device off and on again.
- The Bluetooth device does not support the required profile.
 - ▶ Check the configuration from the Bluetooth device.

9. Disposal

9.1 Disposing of the packaging

ATTENTION!

Risk of environmental damage due to improper disposal of the packaging!

- ▶ Do not put the packaging in the normal household waste.
- ▶ Dispose of the packaging in an environmentally friendly and appropriate manner (recycling).

The packaging serves to protect against transport damage. The packaging materials are selected according to environmentally friendly aspects and are made of recyclable materials. The packaging materials can be returned to the raw material cycle after use.

- ▶ Dispose of the packaging in an environmentally friendly manner, separated according to materials.

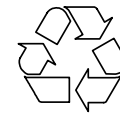

9.2 Disposing of the device

ATTENTION!

Danger of environmental damage due to improper disposal of the device!

- ▶ Do not dispose of the device in normal household waste at the end of its working life.
- ▶ Ask your city or municipal administration about the possibilities of environmentally friendly and proper recycling or disposal of the device.

Correctly handling in the device for recycling makes a contribution to the reuse of materials and the protection of resources.

- ▶ Dispose of the device in accordance with the legal requirements via a specialist disposal company, via your municipal waste disposal facility or by returning it to the distributor who is obliged to take it back.

If batteries or rechargeable batteries are used:

- ▶ Remove the batteries from the device.
- ▶ Dispose of batteries and rechargeable batteries by returning them to the distributor of the battery type or to a municipal collection point.





10. Appendix

10.1 Marks of conformity and certificates

 **Bluetooth**[®] The Bluetooth[®] word mark and logos are owned by Bluetooth SIG, Inc. and are used by sonoro audio GmbH under licence. Other trademarks and brand names are those of their respective owners.

 **Qualcomm**[®] aptX[™]HD Qualcomm aptX is a product of Qualcomm Technologies Inc. and/or its subsidiary companies. Qualcomm is a trademark of Qualcomm Incorporated, registered in the United States and other countries. aptX is a trademark of Qualcomm Technologies International, Ltd. registered in the United States and other countries.

 **Spotify**[®] Use your phone, tablet or computer as a remote control for Spotify. Visit [spotify.com/connect](https://www.spotify.com/connect) to find out how. The Spotify software is subject to third-party licences, which can be found here: <https://www.spotify.com/connect/third-party-licenses/>

 **amazon music** Amazon, Amazon Music Unlimited and all associated logos are trademarks of Amazon.com, Inc. or its subsidiary companies.

 **TIDAL** TIDAL and the TIDAL logo are registered trademarks of Aspiro AB in the European Union and other countries.

 **deezer** Deezer and the Deezer logo are international trademarks of Deezer S.A., registered in France and other countries.

 **Napster**[®] Napster and the Napster logo are registered trademarks of Rhapsody International Inc registered in the United States and other countries.

 **qobuz** Qobuz and its logo are registered trademarks of Xandrie S.A.

Contents

Front of device

Rear of device

Support



The terms HDMI, HDMI High-Definition Multimedia Interface, HDMI Trade Dress and the HDMI logos are trademarks or registered trademarks of HDMI Licensing Administrator, Inc.



AirPlay, iPad, iPad Air, iPad Pro and iPhone are trademarks of Apple Inc., registered in the United States and other countries.

Use of the "Works with Apple" mark means that an accessory has been designed specifically for the technology specified in the mark and has been certified by the developer to meet Apple performance standards.

iTunes is a trademark of Apple Inc. registered in the United States and other countries.

App Store is a service mark of Apple Inc. registered in the United States and other countries.

iOS is a trademark or registered trademark of Cisco in the United States and other countries and is used under licence.

Mac, Mac OS, OS X, macOS Sierra and macOS High Sierra are trademarks of Apple Inc. and are registered in the United States and other countries.



Android, Chromecast built-in and other related trademarks and logos are trademarks of Google LLC.

Microsoft, Windows and Windows Media are either trademarks or registered trademarks of Microsoft Corporation in the United States and/or other countries.

Other company names, product names and logos in this document are trademarks or registered trademarks of their respective owners.

Contents

Front of device

Rear of device

Support

10.2 Declaration of conformity

Manufacturer:

sonoro audio GmbH
 Hammer Landstraße 45
 41460 Neuss
 Germany

We hereby declare that the product

All-In-One Audio Music System MEISTERSTÜCK (Gen. 2)

by virtue of its development, design and construction, complies with the essential requirements of the following Directives:

- Radio Equipment Directive 2014/53/EC
- Ecodesign Directive 2009/125/EC
- Directive on the restriction of the use of certain hazardous substances in electrical and electronic equipment 2011/65/EC

In the event of a modification of the device that has not been approved by the manufacturer, the declaration of conformity automatically loses its validity.



Full text of the EU Declaration of Conformity:
<https://support.sonoro.com>

11.2023

MEISTERSTÜCK (Gen.2) (SO-620)

SUPPORT

support.sonoro.com

Tel: +49 (0) 2131 / 88 34 141



SONORO AUDIO APP

App Store

Google Play Store

V. 1.0.2

sonoro audio GmbH
Hammer Landstraße 45
41460 Neuss, DE

sonoro